



Global Water
800-876-1172 • globalw.com

WL16 Data Logger

Covers WL16S and WL16U Data Loggers



Global Water

Instrumentation, Inc.

151 Graham Road

P.O. Box 9010

College Station, TX 78742-9010

T: 800-876-1172

Int'l: (979) 690-5560, F: (979) 690-0440

globalw@globalw.com



Global Water

800-876-1172 • globalw.com

Congratulations on your purchase of a Global Water WL16 Data Logger. This instrument has been quality tested and approved for providing accurate and reliable measurements. We are confident that you will find the logger to be a valuable asset to your applications. Should you require assistance, our technical staff will be happy to help.

Table of Contents

I.	Checklist	□	□	□	□	□	3
II.	Inspection		□	□	□	□	3
III.	Warranty	□	□	□	□	□	3
IV.	WL16 Specifications	□	□	□	□	□	4
V.	System Requirements		□	□	□	□	6
VI.	Software Installation	□	□	□	□	□	6
VII.	Direct Connection	□	□	□	□	□	9
VIII.	Modem Connection	□	□	□	□	□	10
IX.	Main Screen	□	□	□	□	□	13
X.	On-Line Help Files	□	□	□	□	□	17
XI.	Get History	□	□	□	□	□	18
XII.	Setup Menus	□	□	□	□	□	19
XIII.	General Setup	□	□	□	□	□	20
XIV.	Analog Setup	□	□	□	□	□	23
XV.	Programming	□	□	□	□	□	27
XVI.	Modem Cable Diagram		□	□	□	□	28
XVII.	Adjusting the Zero Reference Level				□	□	29
XVIII.	Maintenance	□	□	□	□	□	32
XIX.	Troubleshooting	□	□	□	□	□	32
XX.	Customer Support	□	□	□	□	□	33



Global Water
800-876-1172 • globalw.com

I. Checklist:

- a. WL16S (Serial) or WL16U (USB) Data Logger
- b. WL16 Data Logger Manual
- c. WL16S comes with a RS-232 Serial Cable
- d. WL16U comes with a USB Cable, Type A to B
- e. Global Logger Interface Software on CDROM

II. Inspection:

- a. Your Data Logger was carefully inspected and certified by our Quality Assurance Team before shipping. If any damage has occurred during shipping; please notify Global Water Instrumentation, Inc. and file a claim with the carrier involved.

III. Warranty:

- a. Global Water Instrumentation, Inc. warrants that its products are free from defects in material and workmanship under normal use and service for a period of one year from date of shipment from factory. Global Water's obligations under this warranty are limited to, at Global Water's option: (I) replacing or (II) repairing; any products determined to be defective. In no case shall Global Water's liability exceed the products original purchase price. This warranty does not apply to any equipment that has been repaired or altered, except by Global Water Instrumentation, Inc., or which has been subject to misuse, negligence or accident. It is expressly agreed that this warranty will be in lieu of all warranties of fitness and in lieu of the warranty of merchantability.
- b. The warranty begins on the date of your invoice.



IV. WL16 Specifications:

Logger:

Power Supply:	Two 9VDC Alkaline batteries standard 8 VDC Min. to 24.0 VDC Absolute Maximum Standby Current: 65uA Typical Logging Current: 5mA Typical + sensor current
Operating Temperature	Industrial, -40°C to +85°C (Battery may not apply)
Analog Sensor Inputs:	4-20mA Resolution: 12-Bit, 4096 Steps 1 channel + battery voltage monitor, 2 nd channel reserved for temperature option Sensor Warm-up Time: Programmable, 0-60 Seconds
Sample Modes:	Fixed Interval: Programmable from 1 Sec. to >1 Year High Speed: 10 Samples per second Logarithmic Sample Rate (Approximation) Exception (Log only on deviation from previous reading)
Storage Capacity:	81,759 Recordings for two analog inputs, battery voltage monitor and date/time stamp
Communication Ports:	WL16S: RS-232 4-pin circular connector WL16U: USB Type B Selectable Baud Rates: Auto Detect or fixed, rates at 9600, 19200, 28800, 38400, 57600, 115200
Housing:	1 7/8 diameter x 11 1/2 long, Stainless Steel and UV protected PVC
Weight:	450g (16oz), Logger only with batteries



Global Water

800-876-1172 • globalw.com

Sensor:

Sensor Element:	Silicone Diaphragm, Wet/Wet Transducer
Range:	Level: 0-3', 0-15', 0-30', 0-60', 0-120', 0-250' Optional Temperature: 32°-122°F (0°-50°C)
Linearity and Hysteresis:	±0.1% FS
Accuracy:	Level: ±0.1% FS at constant temperature ±0.2% over 32° to 70°F range Optional Temp: Smaller of 0.5°F or ±1% of reading
Overpressure:	2 x full scale range
Resolution:	Infinite (Analog)
Outputs:	4-20mA ±1mA at full scale Optional Temperature: 0-10mA ±1mA FS
Supply Voltage:	10-36VDC
Current Draw:	Sum of sensor outputs.
Warm Up Time:	10mS Min, 3 sec. recommended
Operating Temperature:	0° (Not Frozen) to +185°F
Compensated Range:	32° to 70°F submerged, automatic barometric compensation

Housing:

Material:	WL400: 304L Stainless Steel WL400-S: 316 SS
Size:	WL400: 7.5" long x 0.82" diameter WL400-S: 9" long x 1.0" diameter
Weight:	WL400: 110g (4 oz) WL400-S: 250g (9oz)

Cable:

Conductors:	4 each 22 AWG
Jacket Material:	87A shore hardness Polyurethane
Optional jacket:	Fluorinated Ethylene Propylene (FEP) Teflon
Cable O.D.:	7.8mm (0.307")
Vent tube:	HD Polyethylene
Shield:	Aluminum Mylar
Temperature range:	-30 to 85°C (-22 to 185°F)
Weight:	~65g/m (0.7 oz/ft)



V. System Requirements:

Desktop or Laptop computer with:

- 1) Windows 98, ME, 2000, XP Vista or Windows 7 Operating Systems
- 2) CDROM Drive
- 3) RS-232 COM Port (for WL16S) or USB Port (for WL16U)

Note that the software provided with the WL16 data loggers is for running on desktop and laptop computers only. Software for many popular Handheld PDA devices is available from Global Water. Special cables may be required.

VI. Software Installation:

Global Logger Installation: *This software is for use on Windows based desktop and laptop computers only. Insert the software installation CD and run the Setup program. This will install the Global Logger application in the Program Files folder and automatically put the Global Logger icon on the desktop.*

Serial communication (WL16S Only): If you are using the RS-232 serial port to access the data logger, no further action is needed. You can start using the logger by opening the Global Logger application program. Skip the next section.

USB Driver Installation (WL16U Only): With the installation CD in the CDROM drive and DC power applied to the logger, plug the USB cable into the data logger to open the ADD New Hardware Wizard. *The menus that follow will look different for different operation systems but the procedure is the same. **Do not allow the Hardware Wizard to automatically search for the driver. Instead, specify the location (CDROM).*** If a generic driver gets, or has been previously installed, it must be uninstalled before proceeding by using the Add or Remove Programs section of the Control Panel. Instead, click the Search External Media box or Specify a Location box and install the driver from the CDROM. Running the Setup program that installs the Global Logger software also installs a folder with the driver in it. This location can also be specified if the CDROM is not available; although, it is recommended that the driver be installed at the same time the Global Logger is installed.



WL16U Only

The following menus apply to the Windows XP operating system.

1) Do not let Windows search for software. Click “No, not at this time” when asked if Windows Update can search for software.

Click Next.



2) Do not let Windows automatically install the software. Click “Install from a specific location”.

Click Next.

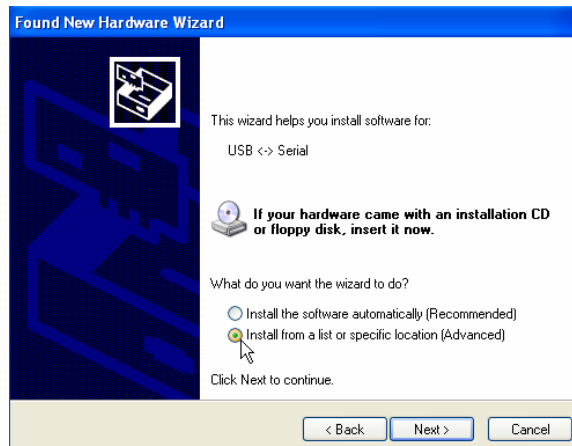

3) Specify the location of the driver. Make sure the Global Logger CDROM is in the CD drive and click “Search removable media” only.

Click Next.

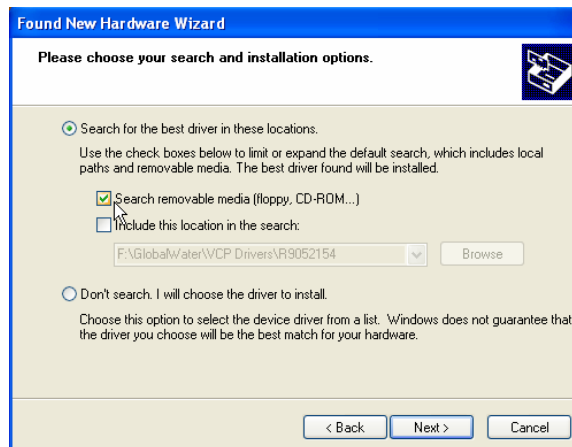



WL16U Only

4) The Hardware Wizard searches for the driver.

If Windows advises that the software is not certified, click:

“Continue Anyway”.

This only means that Microsoft has not licensed the software. Second party software is allowed and no harm will come to your computer.

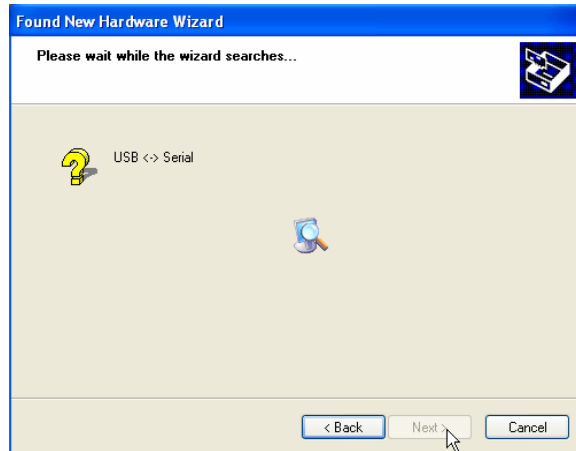

5) The first half of the installation is complete. The Hardware Wizard must make two passes.

Click Finish.



6) Two drivers might be required so the Hardware Wizard may repeat the exact same process again. As before; a: do not let the Windows Update do a search, b: tell Windows to search from a specific location instead of automatically installing software, c: tell Windows to search from removable media (CDROM).

7) The installation is complete.

Click Finish.

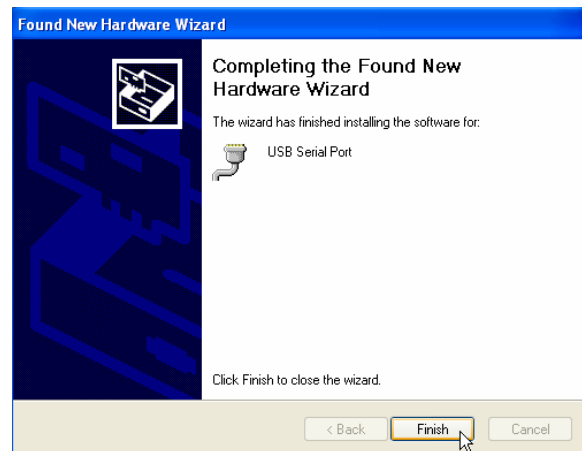



Global Water

800-876-1172 • globalw.com

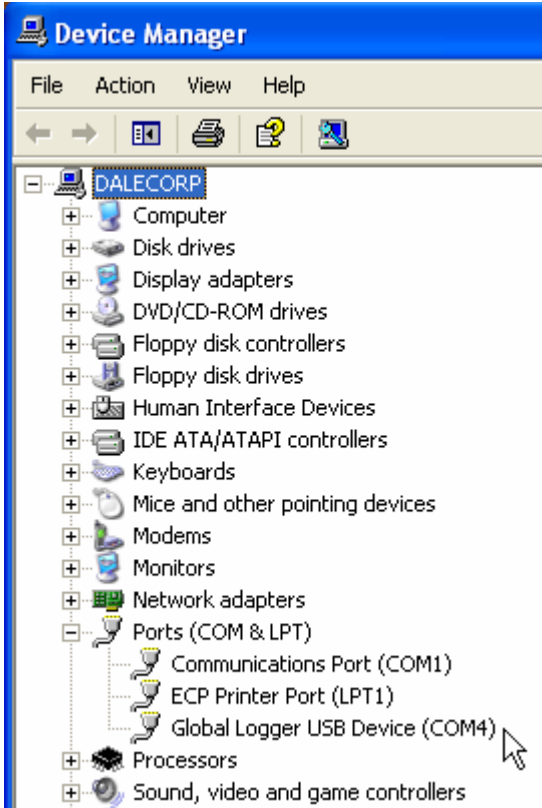

8) To confirm the installation, look in the Device Manager and find the USB Serial Port. The COM setting following that will show the virtual COM port that has been automatically assigned to the driver. As you will see in the following sections, this COM port will be automatically detected by the Global Logger software so it is not necessary to note which port is being used by the driver.

VII. Direct Connection:

Important: This data logger supports an *Auto Baud Rate Mode* which automatically detects the communication speed. However; this communication software also supports loggers which may be programmed in a *Fixed Baud Rate Mode*. This is useful in telemetry applications, particularly when using Global Water data loggers with our Global Access radio modem software. The upcoming discussion assumes that the logger is programmed in auto detect mode. If you cannot connect to the logger and suspect that the logger may be using a fixed rate mode; try each connection speed separately, especially 38400 which is required when using the Global Access software.

There are 3 ways to connect to the WL16 data Loggers, direct connection through the RS-232 serial port (WL16S only) or USB port (WL16U only), as well as dial out through an installed modem (requires WL16S only with external serial modem).

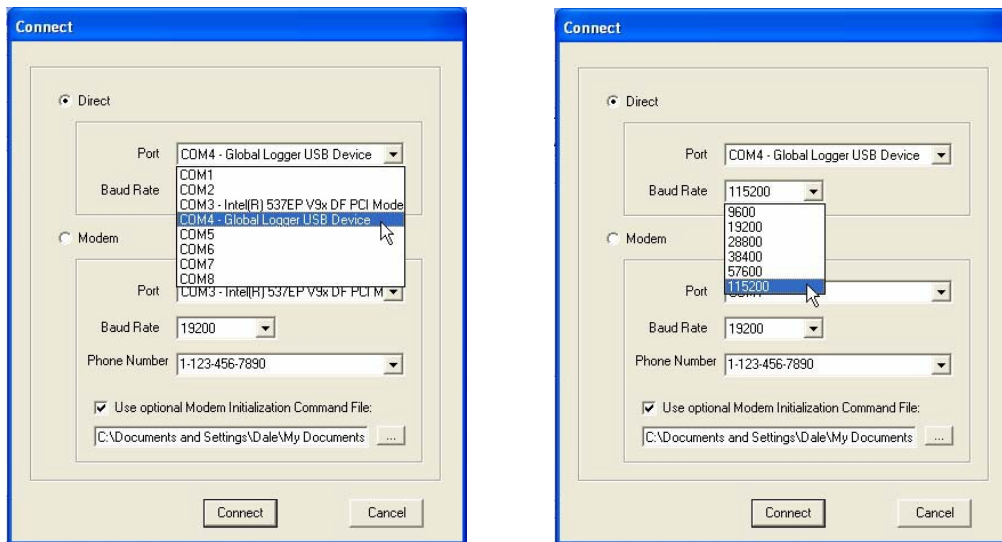

To make a direct connection to the logger, click the “Direct” option and from the “Port” menu, select the port you wish to use.

For USB access (WL16U) select the USB serial port at the COM port the driver was assigned, which is automatically shown in the list as “Global Logger USB Device”.

Serial connection (WL16S) is generally done using the serial cable provided with the logger through the 9-pin COM1 connector at the back of the computer although COM2 can also be used.

Next, select the desired baud rate from the “Baud Rate” menu. Generally, the fastest rate of 115,200 is used although; long cables or other factors may require a slower setting. Click “Connect” to make the connection. If a connection is not made, an error message will appear. Check the battery, communication cable, driver installation and COM port settings.

VIII. Modem Connection (WL16S Only):

Access to the WL16S can be made through dial-out to a remote modem by clicking the “Modem” option. The connection from modem to logger requires an RS-232 serial modem, USB modems are not supported as an interface to the logger; therefore, the WL16U logger cannot be accessed by modem. Also, some switch settings must be made to the remote modem and an initialization file may be required to properly configure the host modem.



WL16S Only

Two baud rates are supported 9600 and 19200. Should you experience difficulty establishing a reliable connection at 19200, try the slower connection speed. Note that due to the slower baud rates and the additional handshaking performed during modem communication, The Global Logger software will operate significantly slower than during a direct connection.

The Global Logger software will remember the last 4 numbers dialed and has a provision for using a stored text file (.txt extension) for initialization of the host modem using standard AT commands. Some experience may be required to configure your modem but a sample command file and some useful tips follow.

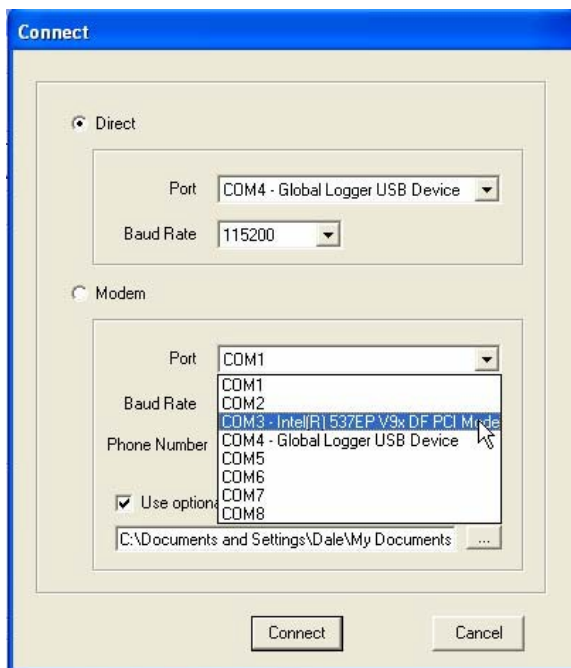

Select the modem's COM port

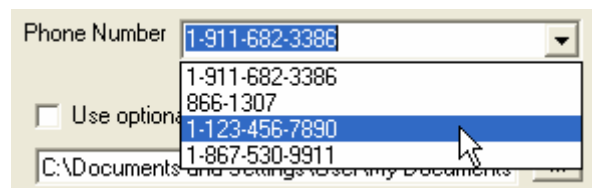
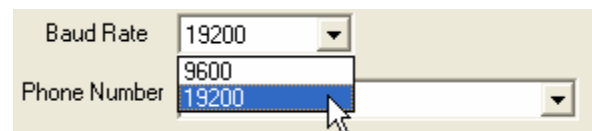

Type in or find the phone number

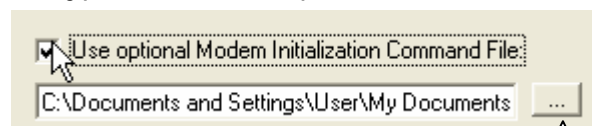

Use initialization file





WL16S Only

Sample initialization text file:

This is for reference and applies to an external US Robotics modem only.

ATM1 ; speaker off when connects
AT&B1 ; fixed serial port rate
AT&D2 ; normal DTR
AT&H1&R2 ; h/w flow control
AT&I0 ; disable s/w flow control
AT&K0 ; disable compression
AT&M4 ; normal error control

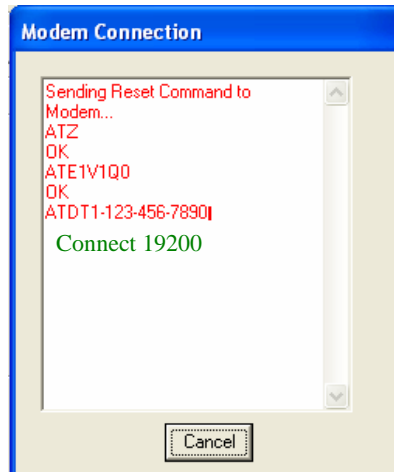

Select the COM port for your modem and the baud rate. Type in the phone number or select it from the list of pre-stored numbers. If necessary, click the "Use Initialization File" box and use the browse button to search for the initialization text file for your modem. Click "Connect" and the software will dial out, showing the status screen shown above.

Once a connection is established, "Connect" will appear for a few seconds along with the baud rate of the connection. After connecting, the normal Global Logger screen will appear and operate exactly as if a direct connection was made. All options and features work the same but at a reduced communication speed.

When connecting the WL16S Data Logger to an external modem, a special cable is required. Wiring diagrams are provided at the end of this manual and pre-wired cables are available from Global Water.

The remote modem is configured by setting DIP switches. They should be set to auto-answer on, DTR Normal, carrier detect normal and smart mode. Global Water can provide external modems and interface cables at an additional cost if requested. Contact our sales department for more information.

It may not be necessary to use an initialization string to configure the host modem but if problems arise the modem should be set with software handshaking off (Xoff), DTR normal, fixed baud rate, compression off and error correction on. This configuration is done by building an initialization file using the standard AT commands and loading it into the connection screen.



IX. Main Screen:

The main screen is where the status and option menus are accessed. The WL16 data logger will continue to log at normal intervals while connected to the Global Logger software. While connected, the logger will draw an additional current from the power supply of 5-10mA so it is advised that, if you plan to not access the logger for extended periods of time, you disconnect to increase battery life. Interface cables may remain connected. To disconnect, click on the "Disconnect" button. This label on this button will change to "Connect" and clicking on it will return you to the connection screen as previously discussed.

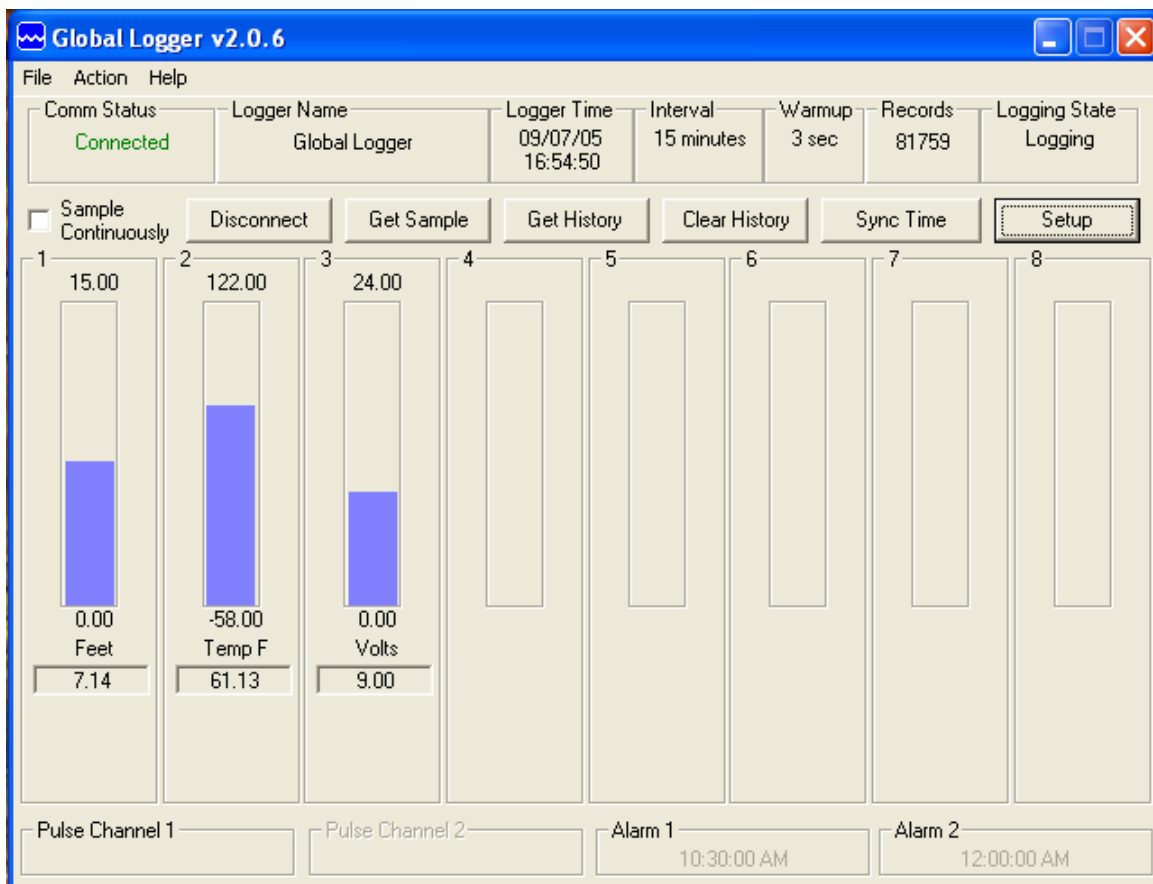

The functions and information in this screen are discussed in the following sections. Note that the second channel is optional and generally used for the water temperature option of the WL400 water level sensor. The screen image above shows water level and temperature although any type of sensor can be connected to the WL16 logger. Battery voltage is always monitored on channel 3.



Tool Bar: The tool bar at the top of the screen has 3 options; File, Action and Help. In this screen, the File option is used to exit the program only. Action allows a menu driven interface to the various functions and displays the hot-keys, which can be used for fast access. In the Help menu; Help allows you to view the on-line help files (see section X, Page 16), About shows contact information and revision information for the Global Logger software and Firmware Version displays the WL16 Data Logger revision number.

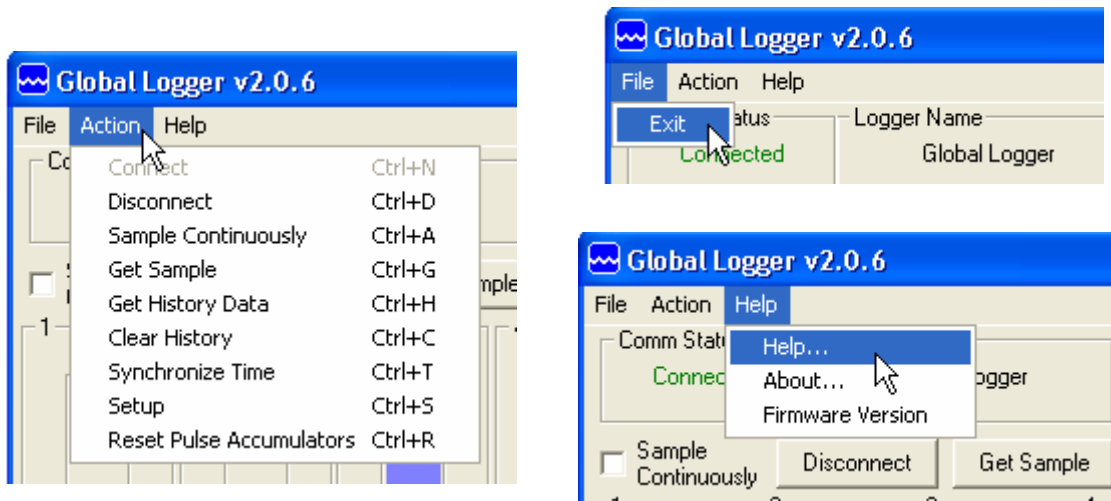

COM Status: This reads “Connected” in green or “Not Connected” in red, depending on the current connection status.

Logger Name: The logger name is a user defined name associated with a particular logger to identify one from another. It is programmed in the Setup menu as described later and is limited to 32 characters.

Logger Time: The time and date displayed is that of the real-time clock in the logger. It is only updated upon initial connection and certain functions that cause data to be read from the logger. These include Sample Continuously, Get Sample, Sync Time and Setup whose functions are to be described later.

Interval: This field displays the logging mode. “Fast” indicates high-speed mode and “Logarithmic” is shown in logarithmic mode. If the logger is in the normal fixed interval sampling mode, the time between samples will be displayed. These modes are to be described later.

Warmup: This displays the sensor warm-up time.



Global Water

800-876-1172 • globalw.com

Records: This field indicates the number of data recordings in memory.

Logging State: This shows whether the WL16 is currently logging or waiting to be started or stopped by the alarm timers. These features are described in detail later.

Sample Continuously: Clicking this check box causes the Global Logger software to take and display a real-time reading once per second until stopped by clicking it again, as well as update the rest of the fields on the screen. These data readings are not stored in the historical record and do not affect the normal recording of the logger. The initial reading has a sensor warm-up time of 50mS and the sensor is left powered up until this feature is turned off.

Get Sample: Clicking this button causes the Global Logger software to take and display a single reading as well as update the rest of the fields on the screen. This data reading is not stored in the historical record and does not affect the normal recording of the logger. The sensor warm-up time is fixed at 50mS.

Get History: This button starts the download of all the historical data stored in the logger memory. Oldest data is collected first and Clicking "Stop" halts the process. This function is described in detail later.

Clear History: This resets the number of recordings in memory to zero. The user is warned first and must confirm the action before the memory is cleared.

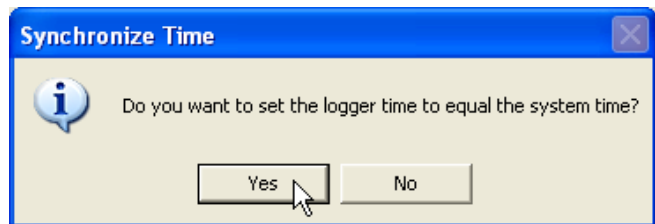
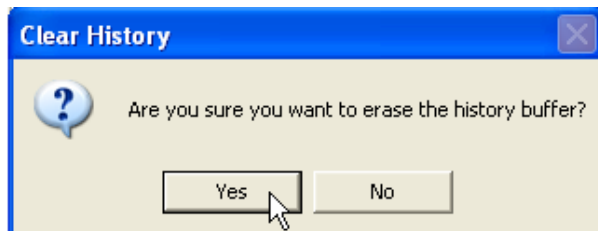

Sync Time: This button causes the data logger's internal clock to be set to the system time of the computer it is connected to. The user is warned first and must confirm the action before the time is set.

Setup: Clicking this button enters the setup screen where the user can change and program all parameters into the data logger. This function is described in detail later.



Global Water

800-876-1172 • globalw.com

Bar Graphs: The bar graphs show a visual representation of the most recent data reading taken by using the Sample Continuously or Get Sample functions. The upper and lower limits of the display are defined by the user as discussed in detail later.

Numerical Reading: The numerical reading at the bottom of the bar graph shows the actual data reading and is updated at the same time as the bar graph. Successive numerical readings taken by using Sample Continuously or Get Sample are shown in a list below the bar, up to 5.

Alarm 1: This field shows the time that the logger is set to start logging. The start alarm is a 24-hour timer which will initiate logging, when enabled, at the next occurrence of that time.

Alarm 2: This field shows the time that the logger is set to stop logging. The stop alarm is a 24-hour timer which will halt logging, when enabled, at the next occurrence of that time after the logger has started recording. If the Alarm 1 timer is set to initiate logging, the Alarm 2 timer will halt logging at the next occurrence of the Alarm 2 time after the logger has been started by Alarm 1. If the Alarm 1 timer is not enabled, the Alarm 2 timer will halt the logger on the next occurrence of that time.

Note: The alarm start and stop cycle is a one time occurrence. Once stopped by the Alarm 2 timer, the logger will not resume logging again until the logger is reprogrammed. Reprogramming the logger with the timers enabled will restart the alarm cycle. Reprogramming the logger with the timers disabled will return the logger to a normal logging state

Use care when programming the alarm times. If left enabled, changing and reprogramming any of the setup parameters will restart the alarm timers and could cause the logger to stop recording.



X. On-Line Help Files:

Clicking on Help displays the on-line help files which contain all of the information contained in this manual. There are 3 ways to access the information. The first tab is **Contents** which accesses the table of contents for the manual. Clicking on any of the topics opens up the body of text on that subject. Within each body of text is a discussion of that subject and links to related topics underlined in blue. Clicking on the link will bring up a new window with specific information on that topic. In this case, Sensor Warm-up time in the General Setup menu.

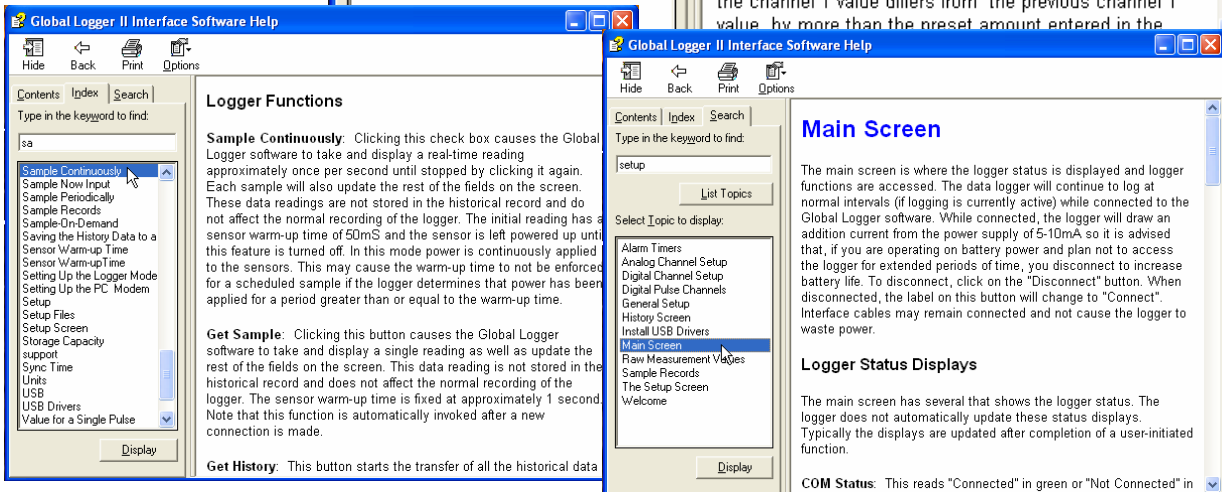
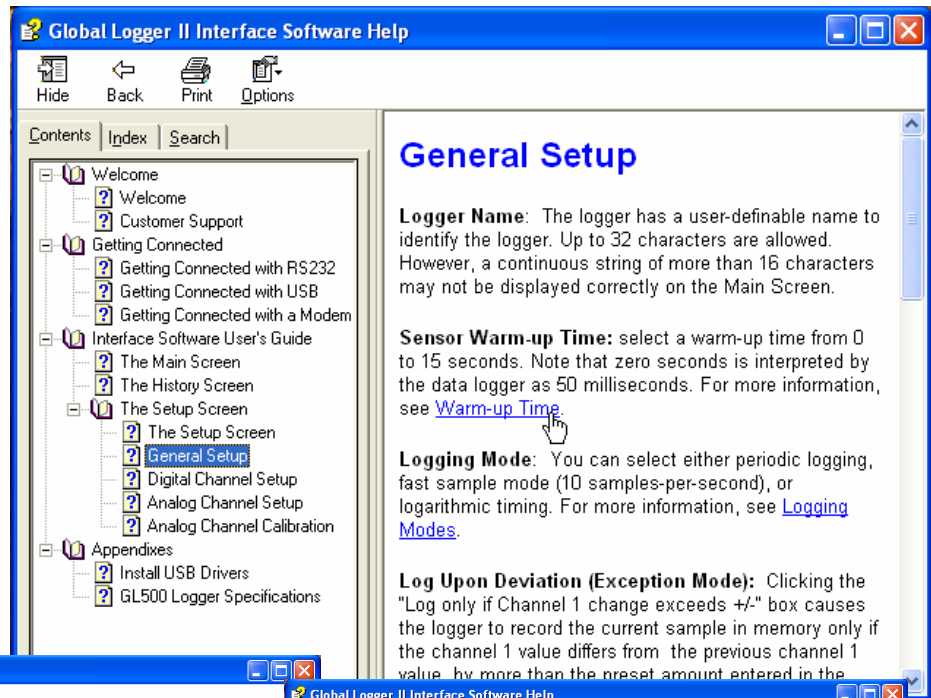

Click the **Index** tab to find a listing of topics. Type letters into the keyword field and the program automatically sorts the topics alphabetically. To find relevant topics based on a keyword, click the **Search** tab. Type in a keyword and click List Topics. When the desired topic is found, double-click on it or click Display at the bottom of the screen to show information on that subject.



XI. Get History:

Clicking the Get History button begins the downloading of the historical data into an information screen. This screen allows the viewing of the recorded data and also provides a path to export the data to an Excel compatible file (.CSV file). Note that the logger continues to log as data is downloaded. Thus, more data points may be downloaded than originally indicated.

Date / Time	Feet	Temp F	Volts	Pulses
10/4/05 07:50:03	0.715	66.3	18.89	0
10/4/05 08:00:03	0.714	66.3	18.87	0
10/4/05 08:10:03	0.713	66.2	18.85	0
10/4/05 08:20:03	0.713	66.2	18.84	0
10/4/05 08:30:03	0.712	66.2	18.83	0
10/4/05 08:40:03	0.712	66.2	18.81	0
10/4/05 08:50:03	0.711	66.1	18.80	0
10/4/05 09:00:03	0.710	66.1	18.79	0
10/4/05 09:10:03	0.710	66.1	18.78	0
10/4/05 09:20:03	0.710	66.1	18.77	0
10/4/05 09:30:03	0.710	66.1	18.77	0
10/4/05 09:40:03	0.710	66.1	18.77	0
10/4/05 09:50:03	0.710	66.1	18.77	0
10/4/05 10:00:03	0.710	66.1	18.76	0
10/4/05 10:10:03	0.710	66.0	18.76	0
10/4/05 10:20:03	0.710	66.0	18.76	0
10/4/05 10:30:03	0.709	66.0	18.76	0
10/4/05 10:40:03	0.709	66.0	18.75	0
10/4/05 10:50:03	0.709	66.0	18.74	0
10/4/05 11:00:03	0.708	66.0	18.73	0
10/4/05 11:10:03	0.708	66.0	18.72	0
10/4/05 11:20:03	0.708	66.0	18.71	0

At the top of the screen is shown the name assigned to the logger and the number of recordings that have been retrieved. At the bottom of the screen are three buttons, Pack, Save to File and OK.

Pack: The Pack function removes recordings that are identical to the previous ones. All the channels must be the same as the row above for it to be removed. If even a single channel has data that differs from the previous sample, the row will not be removed. This function works best when a single channel is being recorded and allows only the data showing changing conditions to be viewed.



Save to File: Clicking this button allows the data to be exported to an Excel compatible .CSV file. Specify the path and the file name and click the Save button

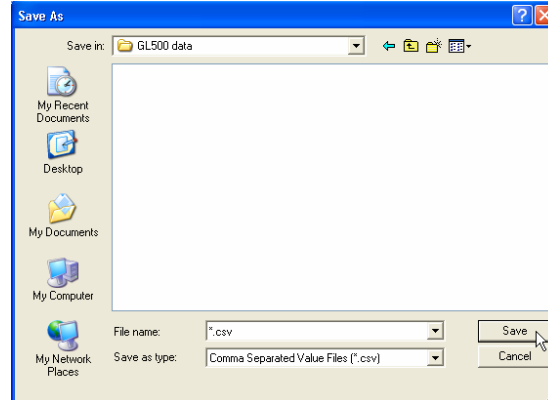

Options: This opens a menu which Allows you to select if you want the Time and date in the time stamp to Be in one column or two in the saved .CSV file. Click Close to return.

OK: Clicking the OK button returns you to the main screen.

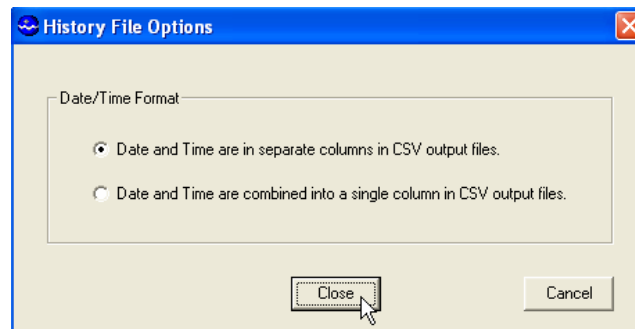

XII. Setup Menus:

Clicking the Setup button enters the setup menu which is composed of three sections, Analog, Digital and General. The first screen to appear is General Setup. At the top of the setup screen is a toolbar with three options, File, Action and Help.

File: The File option allows you to exit the setup screen but most importantly, it allows all of the configuration information for the logger to be saved to a file or restored from a file. Select "Load Setup File" to restore a configuration from a file that has been previously saved or "Save Setup File" to save the current setup and calibration information. The last 4 files are shown for convenience. Setup files have a .SET extension. *It is advised that after you calibrate and configure the logger, you save the configuration to a file as a backup precaution before exiting the setup menu.*

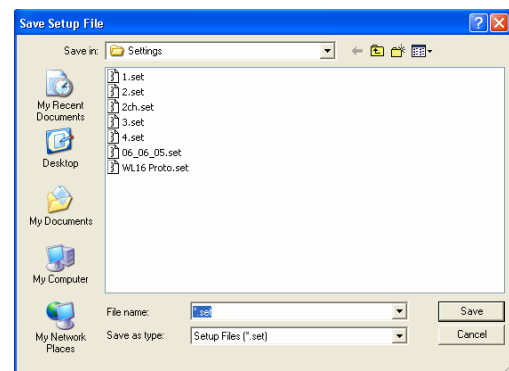
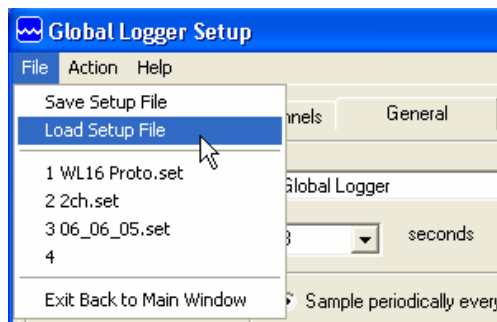



Action: The Action menu has two options, "Program Settings" and "Initialize to Default Values". Program settings will reprogram the data logger with all the setup and calibration information and works the same as the Program Settings Button at the bottom of the screen. Initialize will restore all of the analog, digital and general setup information fields to default values. Only the setup menus are changed, the data logger must still be programmed with the new default values. A warning message will appear before this action is taken.

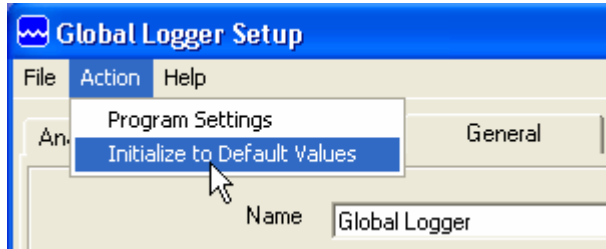

Help: The Help menu provides access to the on-line help files and Global Water contact information as described previously.

XIII. General Setup:

In the General Setup menu, the logger name, sensor warm-up time, logging mode, logging interval and alarm times are entered.

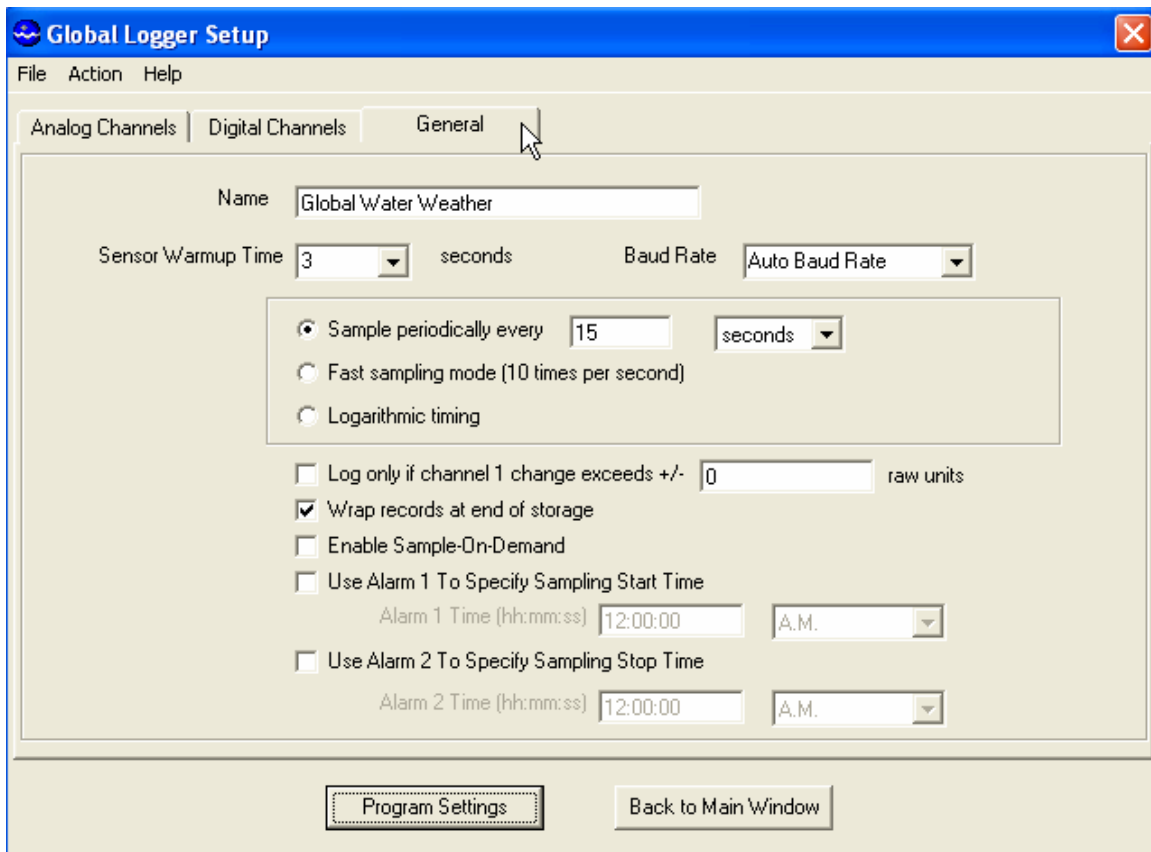



Global Water

800-876-1172 • globalw.com

Name: The logger is a user definable name to identify the logger. Up to 32 characters are allowed however, a continuous string of characters of more than 16 with no spaces may not be displayed correctly. Click on the field to enter information.

Sensor Warm-up Time: To conserve battery life, the sensors do not normally have power applied to them. Before taking a reading, the logger powers up the sensors for the sensor warm-up time, and then removes power from them again. The allowable times are zero (50mS) to 60 seconds. Click on the field to enter or select the time in seconds from the pull-down menu.

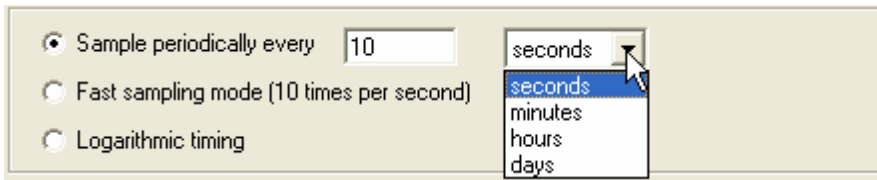
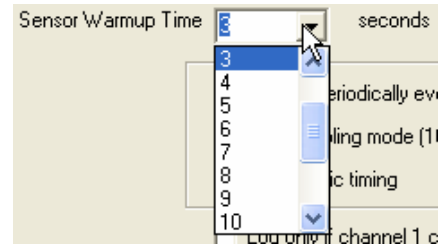

Baud Rate: Leave this set to Auto Baud Rate.

Only change this to a fixed baud rate if planning to use this logger in a telemetry application, such as using Global Water’s Global Access radio modem software. Once programmed in a fixed rate mode, you must set the baud rate in the opening connection menu of the Global Logger II software to this speed, or the logger will not communicate.

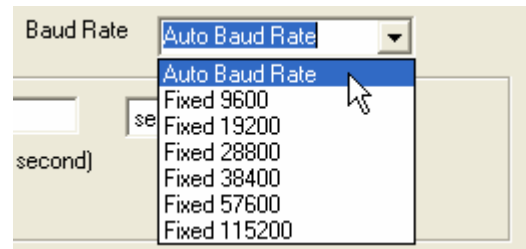

Sample Periodically: Sampling at regular intervals is the most common recording mode. Click the Sample Periodically option, select the units from the pull-down menu and click the numerical field to enter the number of those units up to 65,535.

Fast Sampling Mode: In Fast mode, the sample rate is fixed at 10 times per second. The time stamp will not read fractions of a second so there will be 10 samples per time stamp. Click the Fast mode option to select this feature.



Global Water

800-876-1172 • globalw.com

Logarithmic Timing: Typically used in groundwater pump studies, this mode speeds up the sample rate over time. Click the “Logarithmic” option to select this mode. This a logarithmic approximation that steps up the sample rate:

- a. 10 times per second for 20 seconds, 200 samples
- b. 1 second interval for 100 seconds, 100 samples
- c. 10 second interval for 10 minutes, 60 samples
- d. 1 minute interval for 60 minutes, 60 samples
- e. 10 minute interval for 10 hours, 60 samples
- f. 1 hour interval for 48 hours, 48 samples
- g. 1 day interval until memory s full

Log only if channel 1 change exceeds +/- raw units
 Wrap records at end of storage

Log Upon Deviation: Clicking the “Log only if Channel 1 change exceeds +/-” box causes the logger to record the current reading in memory only if it exceeds the previously reading by the preset amount entered in the numeric field. This logging exception applies to channel 1 only and the deviation is measured in Raw Data units where the approximate raw data range is from 0-65535, corresponding to 0-20mA.

To find the actual number of raw data units per engineering unit, use the calibration numbers in the Analog Setup screen for channel 1 as follows: Raw Data Units per Engineering Unit = (High Raw – Low Raw) / (High EU – Low EU). For example: Assume a 15 foot water level sensor has a High EU of 15, a Low EU of zero, a High Raw of 62256 and a Low Raw of 13104. $(62256-13104) / (15-0) = 3277$ units/foot. Thus, if you want to log only when a reading exceeds the previous on by 0.5 feet, set the deviation to about 1638. Click the numeric field to enter the desired range.

Enable Sample-On-Demand
 Use Alarm 1 To Specify Sampling Start Time

Wrap records: If the “Wrap records at End of Storage” box is checked, once the memory is full, the oldest data points will be replaced with the newest. Thus, the memory block represents only the newest. If this feature is not checked, the logger will halt recording once the memory is full.

Sample-On-Demand: This feature is not supported by the WL16 data loggers.



Global Water

800-876-1172 • globalw.com

Alarm Times: Check the box associated with each alarm to enable that feature and enter the desired start or stop time. The logger will start at the next occurrence of the Alarm 1 time and stop at the next occurrence of the Alarm 2 time after the Alarm 1 timer has expired. Either or both alarms can be enabled

Use Alarm 1 To Specify Sampling Start Time
Alarm 1 Time (hh:mm:ss) 11:00:00 A.M.
Use Alarm 2 To Specify Sampling Stop Time
Alarm 2 Time (hh:mm:ss) 10:00:00 A.M.

Note: Use care when programming the alarm times. If left enabled, changing and reprogramming any of the setup parameters will restart the alarm timers and could cause the logger to stop recording and the loss of important data.

XIV. Analog Setup:

The Analog Setup screen sets the engineering units and calibration numbers for each of the analog channels, the endpoints of the bar graphs in the main screen and which of the analog channels are enabled. These channels are calibrated in the same way so a single channel will be discussed. *It is important to note here that the information stored in the data logger's memory is just the sensors output level before it is adjusted by the following calibration parameters. These parameters are used to adjust the stored data for display and storage purposes only, at the time the data is downloaded. If they are changed, the same stored data can be downloaded again and the data will be scaled differently according to the new settings.*

Global Logger Setup

File Action Help

Analog Channels | Digital Channels | General

	1	2	3	4	5	6	7	8
Enable	<input checked="" type="checkbox"/>	<input checked="" type="checkbox"/>	<input checked="" type="checkbox"/>					
Units	Feet	Temp F	Volts					
High EU	8	95	24					
Low EU	0	32	0					
High Raw	33216	54880	62384					
Low Raw	13104	37680	0					
Disp High	15	122	24					
Disp Low	0	-58	0					
Decimal Places	2	2	2					
Calibrate	Calibrate	Calibrate	Calibrate					

Program Settings | Back to Main Window



Global Water

800-876-1172 • globalw.com

The calibration of channel one to a water level sensor is discussed in the following example where it is not possible to calibrate the sensor over its full range. The water level sensor shown is designed to measure over the range of 0-15 feet but a water column of 15 feet may not be available. The sensors can be calibrated over any range such as 0 to 8 feet, even when it is desirable to measure beyond these limits.

Enable: If the "Enable" box at the top of a column is checked, data for that channel will be shown in the historical record and be available for export to Excel. The data for all the analog channels is always being recorded whether the channel is enabled or not.

Units: This field shows the units that will appear at the top of the data column for that channel in the historical record as well as the display of data in the main screen. Click on the field to enter the unit or select from a predefined list.

High EU: The High EU field is the engineering unit where the highest output from the sensor is achieved during the calibration process, in this case a water level of 8 feet.

Low EU: The Low EU field is the engineering unit where the lowest output from the sensor is achieved during the calibration process, in this case a water level of zero.

High Raw: This is the raw data value as measured by the WL16 Data Logger that corresponds to the High EU value and is automatically set by the calibration process. In this case, the raw data value returned by the logger at a water level of 8 feet.

Low Raw: This is the raw data value as measured by the logger that corresponds to the Low EU value and is automatically set by the calibration process. In this case, the raw data value returned by a water level of zero.



Global Water

800-876-1172 • globalw.com

Disp High: This field sets the upper limit of the bar graph displayed in the main screen and provides a way of scaling the graph beyond the upper limit used to calibrate the logger. In this example, the upper calibration point was a water level of 8 feet but the maximum range of the sensor is 16 feet.

Disp Low: This field sets the lower limit of the bar graph displayed in the main screen and provides a way of scaling the graph beyond the lower limit used to calibrate the logger. In this example, the lower calibration point was a water level of zero.

Decimal Places: From the pull-down menu, select the number of decimal places to the right of the decimal point that should appear in the historical data and in the numerical data field at the bottom of the bar graph.

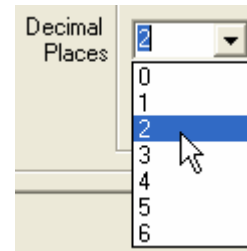

Calibrate: The "Calibrate" button provides a simple 4-step process for calibrating the WL16 Data Logger to a particular sensor. Click the Calibrate button and follow the menu instructions.

Click on the High EU field and enter the high engineering unit that will be used to calibrate the logger, *not the highest reading the sensor can output*. In this example of water level, a depth of 8 feet used to calibrate the logger, even though the sensor can measure up to 15 feet.

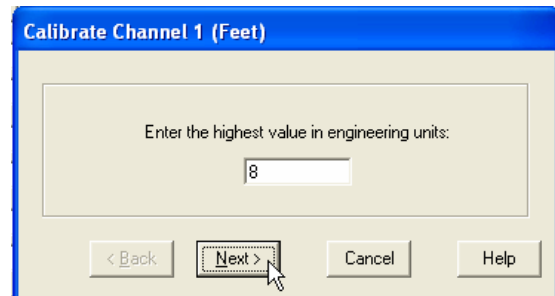

Click Next.

Place the sensor in the condition that will cause it to output the level corresponding to the high EU entered in the previous menu. Wait for the data reading to stabilize.

Click Next.

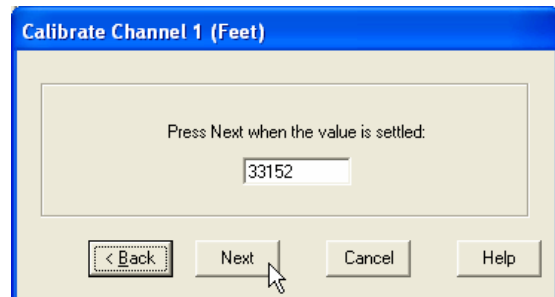



Click on the Low EU field and enter the low engineering unit that will be used to calibrate the logger, *not necessarily the lowest reading the sensor can output*. In this example, the value is zero feet, which is the lowest calibration point and water level.

Click Next.

Calibrate Channel 1 (Feet)

Enter the lowest value in engineering units:

0

< Back Next Cancel Help

Place the sensor in the condition that will cause it to output the level corresponding to the low EU entered in the previous menu. Wait for the data reading to stabilize.

Click Next to complete the calibration.

Calibrate Channel 1 (Feet)

Press Next when the value is settled:

13216

< Back Finish Cancel Help



XV. Programming

Program Settings: The Program Settings button at the bottom of the setup menus will cause all the setup and calibration information to be programmed into the data logger. A warning will appear requiring the use to confirm the action. Click Yes to program the logger and No to cancel the operation.

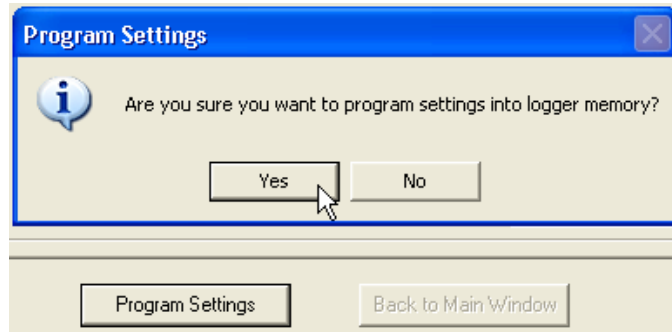

Back to Main Window: The Back to Main Menu button exits back to the main screen. If no settings have changed, Exit will occur immediately. If settings have changed but not saved yet, a message will appear that asks the user if they would like to save them now. If the

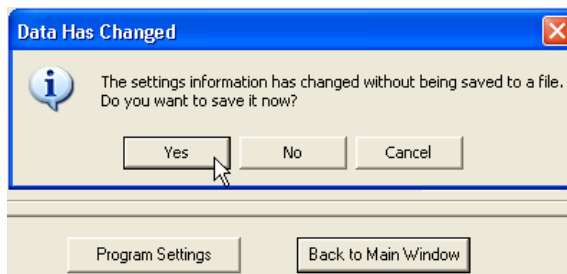

settings have changed but not yet programmed into the logger, another message will be shown asking if the logger should be reprogrammed.

These layers of protection are designed to prevent the user from unintentionally changing settings or forgetting to save the configuration file. Should the settings accidentally be changed, a saved configuration file can be loaded and used to restore the original settings.

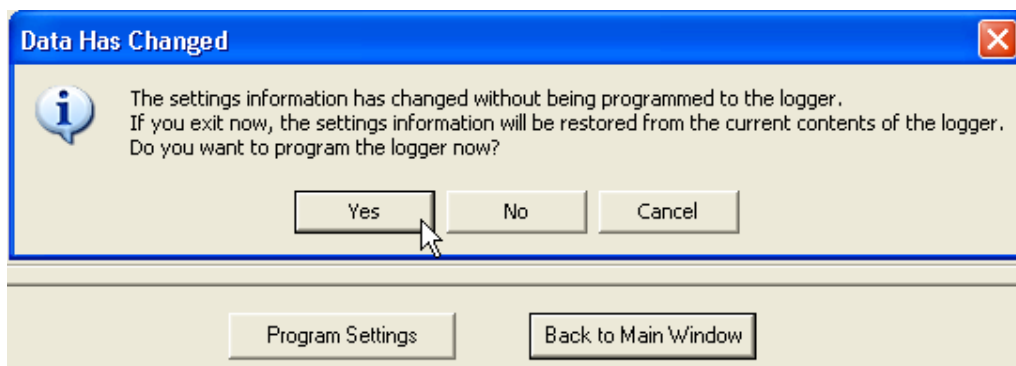



XVI. Modem Cable Diagram (WL16S Only):

The following wiring diagram is used to make a cable to connect the WL16S Data Logger to an external modem. A pre-wired cable is available from Global Water.

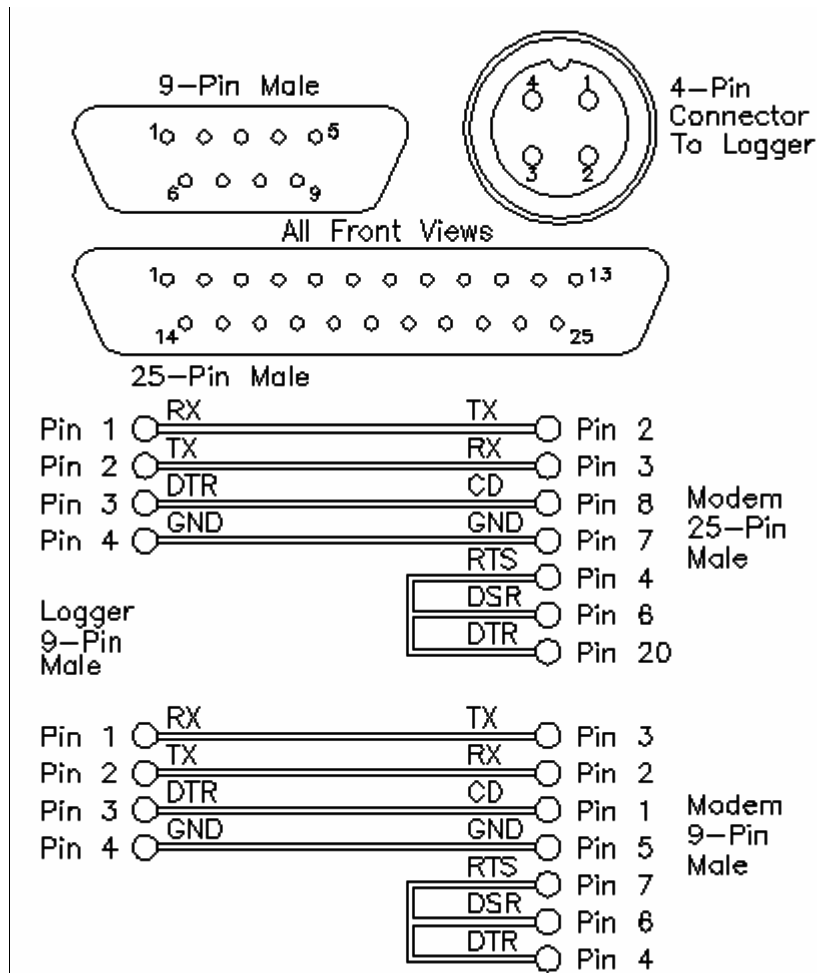



XVII. Adjusting the Zero Reference Level:

The sensor on the WL16 level logger measures the depth of water from the end of the sensor to the surface. However, it is sometimes desirable to know the water depth from a reference level other than the surface. For example: In a ground water well, you may want to know the distance from the surface of the water to ground level, not to the sensor.

The WL16 comes factory calibrated to measure depth from sensor to surface. Setting the reference level to something other than the water surface is easily accomplished by manually changing the Low EU and High EU numbers in the Analog Setup menu. If done correctly, this does not change the calibration of the sensor but rather, just changes the scale of the data to read in any desired range. ***Just one rule must be followed: The difference between the High EU and Low EU numbers must be equal to the depth at which the sensor was calibrated.***

For example: If you have a sensor with a range of 0-30 feet, the logger has been factory calibrated at a range of 30 feet. The High and Low EU numbers can be changed to read any range without changing the accuracy, as long as the difference between them remains 30 feet. If you need to recalibrate the WL16 but do not have a 30 foot depth of water available, you can recalibrate at 20 feet (or whatever is available to you) as long as the difference between the High and Low EU numbers is equal to the calibration depth (in this case, 20 feet).

If you wish to record the depth from sensor to water surface, the Low EU number is always zero and the High EU number is always equal to the depth at which the sensor was calibrated. Selecting a reference level other than the water surface is illustrated in the following examples.

Example 1:

Recording the distance from the top of the well pipe to water level:

Changing the zero reference to the top of the well pipe requires that you know the distance from the top of the pipe to the end of the sensor at the time of installation. Note that the cable length provided with the WL16 is not exact and should not be used as a standard without first measuring it. To change the High and Low EU fields, and thus the recorded level, follow these steps:

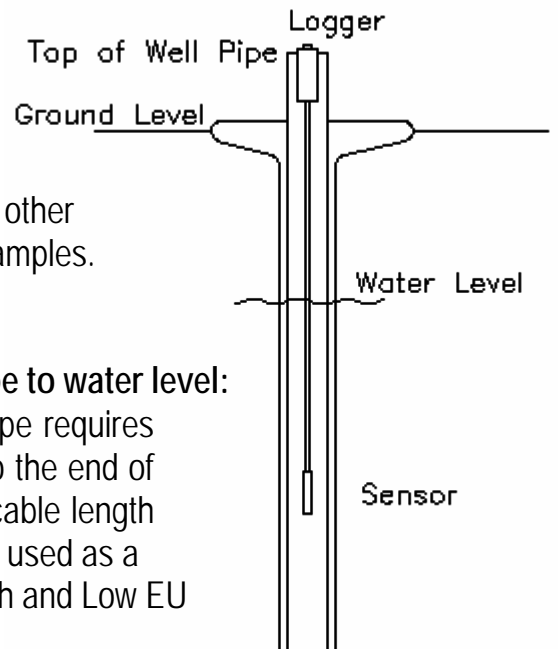



Global Water

800-876-1172 • globalw.com

- Install the WL16 as it will be in the final installation.
- Place a mark on the cable or logger housing at the point where it meets the top of the well pipe (or other desired reference level).
- Remove the WL16 and measure the distance from the tip of the sensor to the mark made in the previous step.
- Enter this length in the Low EU field in the Setup menu.
- Using the depth used to calibrate the sensor and the Low EU number from the previous step, subtract the larger number from the smaller one.
- Enter this new number in the High EU field.
- Re-program the data logger according to the programming procedure.
- Re-install the WL16 the same as before.

Assume that a sensor with a 30 foot maximum range is installed at a depth of 40 feet from the top of the well pipe and that the Low and High Raw data numbers were set at a 25 foot depth. The sensor is installed, a mark is made on the cable where it meets the top of the well pipe, and then removed. The cable is measured at 40 feet from the mark to the tip of the sensor and 40 is entered in the Low EU field. Since the High Raw data number was set at the calibration depth of 25 feet, 25 is subtracted from 40 and the result of 15 is entered in the High EU field.

Example 2:

Recording the relative change in water level:

If it is not important to know the exact distance from the water surface to the sensor or ground level, but only how much the level rises and falls over time, you may want to set a zero reference point equal to the minimum water level (or some other reference point).

Note: The data stored in the logger's memory is not affected by changing the High and Low EU numbers.

The data can be downloaded and analyzed, then the EU fields can be changed to re-scale the data during the next download process to set any desired reference level. This process can be repeated over and over without changing the logger's memory. This allows you to restore the data to its original calibration.

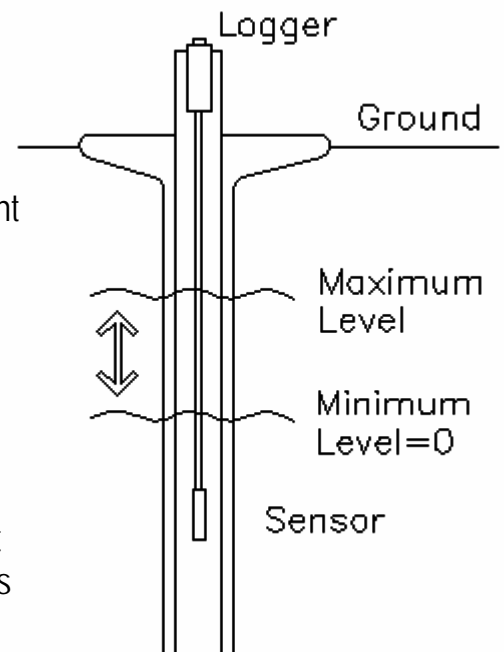



Assume that you wish to set the zero reference point to the lowest water level in the data record. This will show this low level as zero and all others as a positive level above it.

- Download the historical data and find the lowest water level in the record.
- Enter the setup menu and note the difference between the Low and High EU numbers; this is always the depth at which, the sensor was calibrated.
- Type the lowest water level from the data record into the Low EU field.
- Add this number to the calibration depth and enter it into the High EU field.
- Re-program the data logger according to the programming procedure.

Suppose you want to set the zero reference level to that of a specific event (date/time or a specific event such as a significant rainfall or a well pump turning on). Note that this will set a zero reference. Other levels are relative to this and can include negative numbers.

- Download the historical data and find the water level in the record for the reference date/time (or special event) you are interested in.
- Enter the setup menu and note the difference between the Low and High EU numbers; this is always the depth at which, the sensor was calibrated.
- Type the water level from the data record which corresponds to the specific date/time or event into the Low EU field.
- Add this number to the calibration depth and enter it into the High EU field.
- Re-program the data logger according to the programming procedure.

Suppose you want to set the current water level as the zero reference.

If you want the current level to read zero you must only take a single reading and offset the Low and High EU numbers by that amount. Note that this will set a zero reference and that other levels are relative to this and can include negative numbers.

- Install the WL16 and take a reading.
- Enter this reading into the Low EU field as a negative number. If you measure 8.35 feet, enter -8.35 as the new Low EU.
- Add the calibration depth to this number and enter it in the High EU field.
- Re-program the data logger according to the programming procedure.



XVIII. Maintenance:

- a. Except for battery and desiccant, there are no user-serviceable parts inside the WL16 Data Logger.
- b. Global Water recommends checking the batteries every 6 months.
- c. Clean the sensor screen using clean water and a toothbrush to remove any algae, mud or sludge.

XIX. Troubleshooting:

Issue: Logger is reading incorrectly.

- a. Verify the battery supply has enough voltage. To operate properly, the logger and sensor must have a minimum of 8 volts. If the battery voltage monitor is reading less than 15 volts or seems incorrect, check the batteries with a voltmeter or replace them. Battery voltages of less than 15 volts indicate that the batteries need replacing.
- b. Check the logger and sensor calibration numbers in the Setup Menu. Recalibrate the logger if necessary. As a precaution, save the setup file first as described in section XI. Clean the sensor screen.

Issue: Cannot communicate with the logger.

- a. Verify that good batteries are installed.
- b. Check the communication cable.
- c. If the connection is to the WL16S using the serial cable provided by Global Water, verify that the correct COM port is selected in the connection menu of the Global Logger software.
- d. If the connection is to the WL16U through the USB port, use the Device Manager to confirm that the driver is loaded and the correct virtual COM port is selected in the connection menu of the Global Logger software. Check the Device Manager in your operating system and confirm that the USB COM port is not being used by another device.
- e. Try reducing the baud rate in the connection screen of the Global Logger software.



Global Water
800-876-1172 • globalw.com

XX. Customer Support:

Call Global Water for tech support: 800-876-1172 or 979-690-5560 (many problems can be solved over the phone). Fax: 979-690-0440 or Email: globalw@globalw.com.

When calling for tech support, have the following information ready:

1. Model #.
2. Unit serial number.
3. P.O.# the equipment was purchased on.
4. Our sales number or the invoice number.
5. Repair instructions and/or specific problems relating to the product.

Be prepared to describe the problem you are experiencing including specific details of the application, installation, and any additional pertinent information.

In the event that the equipment needs to be returned to the factory for any reason, please call to obtain an RMA# (Return Material Authorization). Do not return items without an RMA# displayed on the outside of the package. Include a written statement describing the problems.

Send the package with shipping prepaid to our factory address. Insure your shipment; Global Water's warranty does not cover damage incurred during transit.